

LEFT SIDE VIEW OF CONTAINER

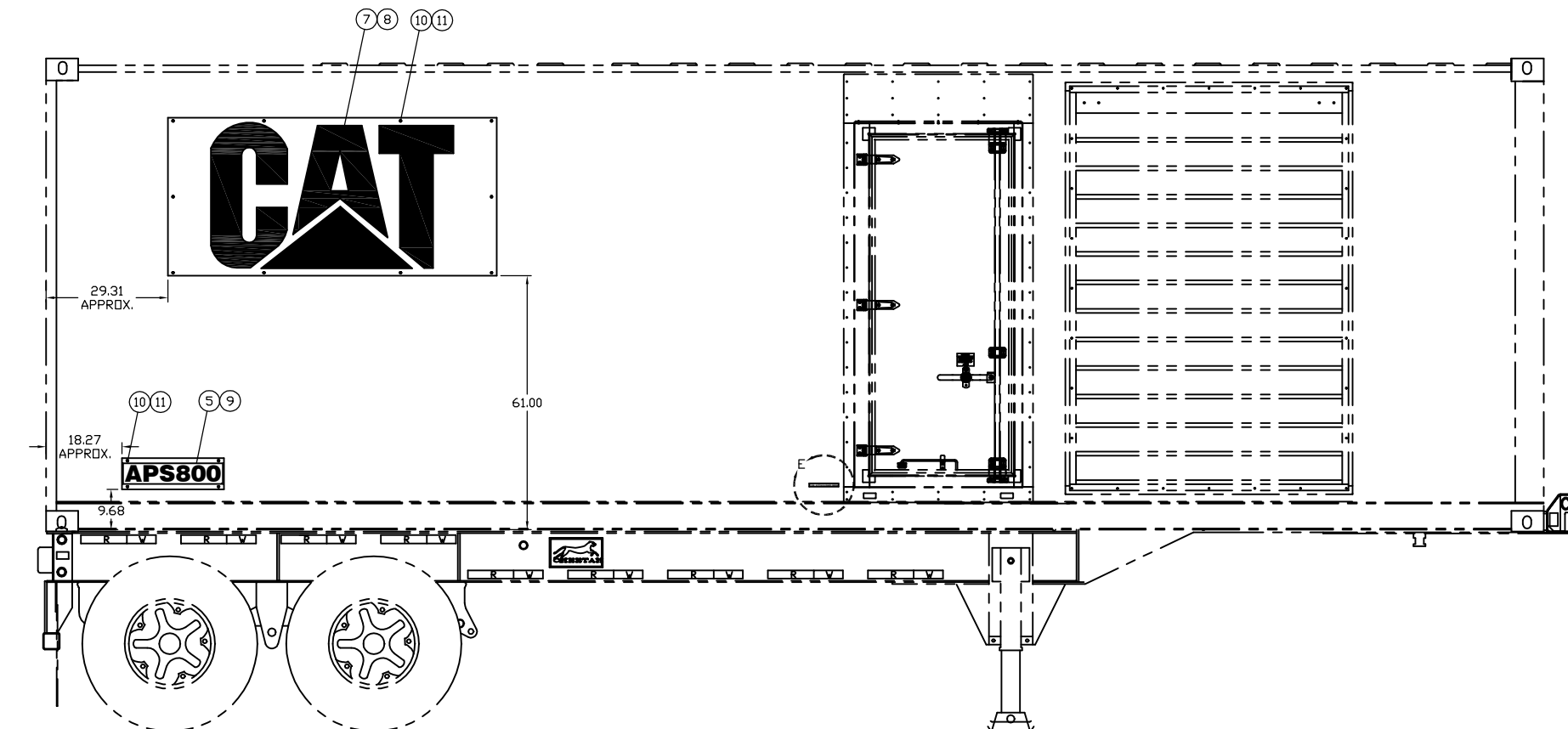

RIGHT SIDE VIEW OF CONTAINER

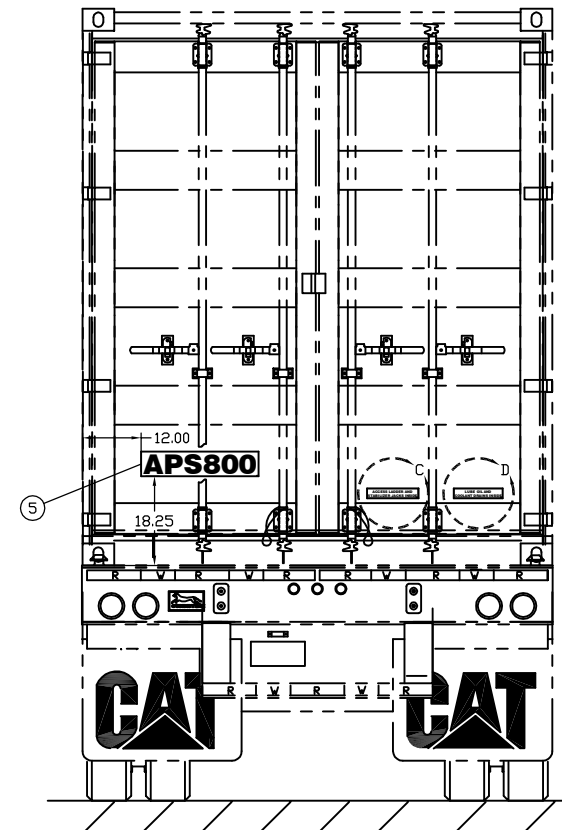

ITEM	QTY.	PART NO.	DESCRIPTION
1	1	80G104	INFORMATIONAL FILM
2	1	80G105	INFORMATIONAL FILM
3	1	80G106	INFORMATIONAL FILM
4	1	80G107	INFORMATIONAL FILM
5	3	80G110	INFORMATIONAL FILM
6	2	80G121	INFORMATIONAL FILM
7	2	7E-7799	FILM-TRADEMARK
8	2	80C192	14 GA. 38.00 X 79.00
9	2	80C193	14 GA. 7.50 X 24.50
10	28	30840	PSQ SMS 14X1 Z A KEG
11	28	N1125257	1/4" NEOPRENE WASHER

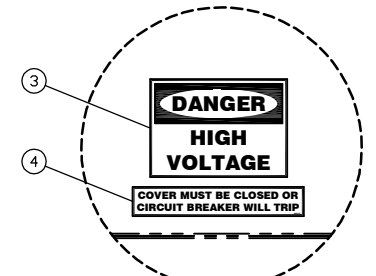

VIEW A
AT E-6
SCALE 4=1

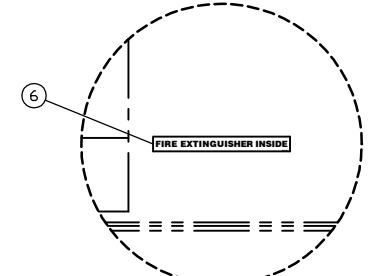

VIEW B
AT E-5
SCALE 4=1

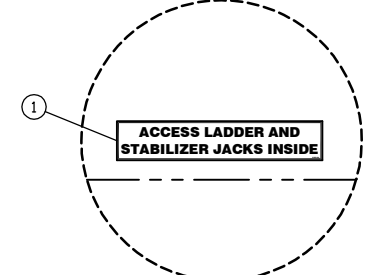

VIEW C
AT E-2
SCALE 4=1

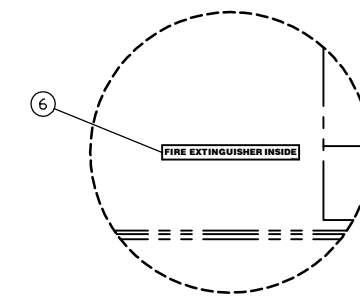

VIEW E
AT B-6
SCALE 4=1

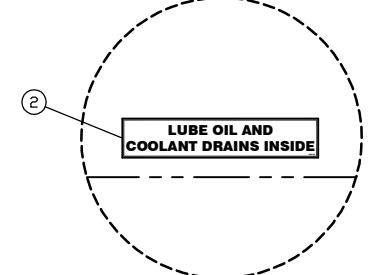

VIEW D
AT E-2
SCALE 4=1

DATE BY		ALTORFER		ALTORFER POWER SYSTEMS	
		6315 W. FAUBER RD.		PHONE (309) 697-1234	
		BARTONVILLE, IL 61607		FAX (309) 282-7546	
CHANGE NOTICE	ALL DIMENSIONS IN INCHES UNLESS OTHERWISE SPECIFIED	FILE	DF/80G	PROJECT REFERENCE	
	TOLERANCES: XX ± 0.100 X.XX ± 0.060 X.XXX ± 0.005	THIRD ANGLE PROJECTION	SCALE/SHEET SIZE	DRAWN BY	QUOTE NUMBER
	ANGULAR ± 1°		1=20/D	J. DILTMAN	WORK ORDER NUMBER
			SHEET	DATE	1-21-05
1	TITLE	1 OF 1			DRAWING NUMBER
		EXTERIOR FILM GROUP			80G100

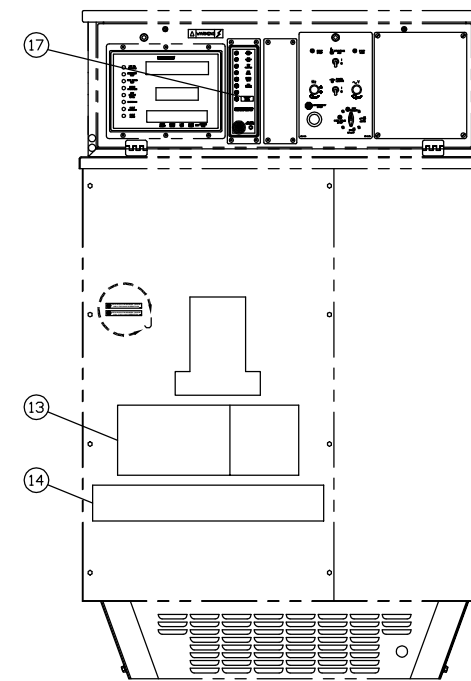
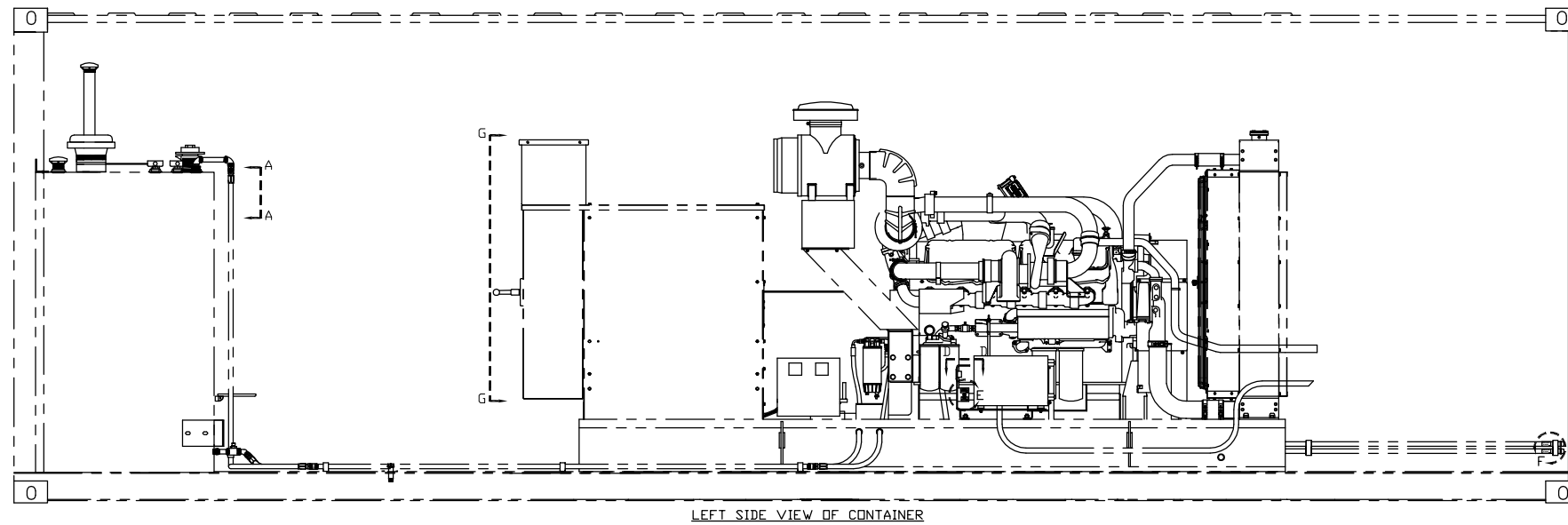
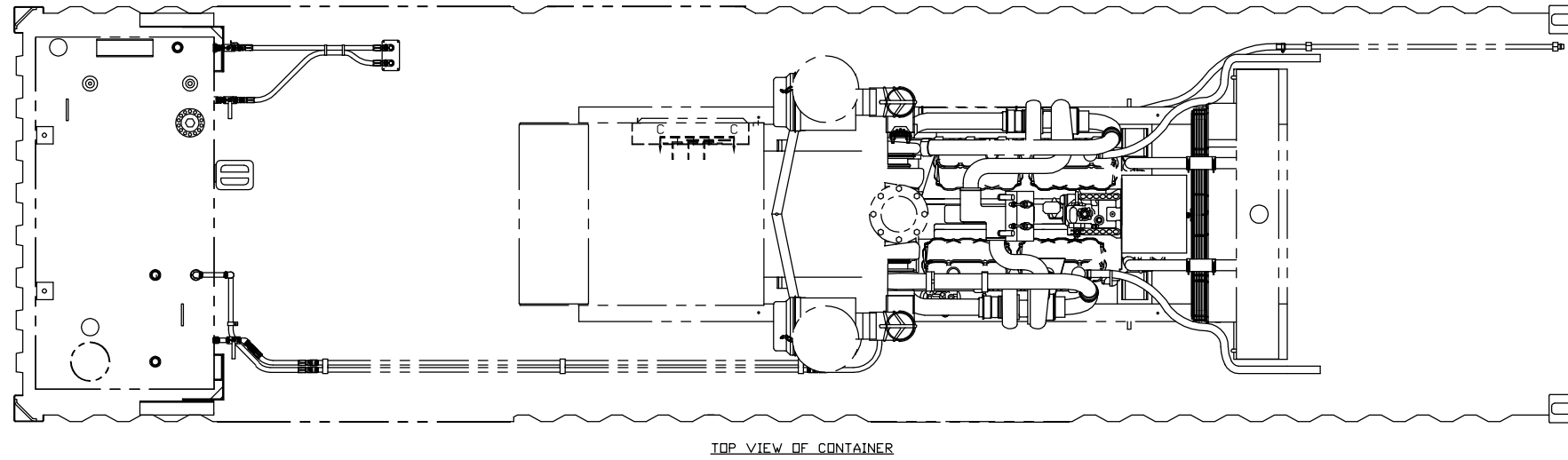
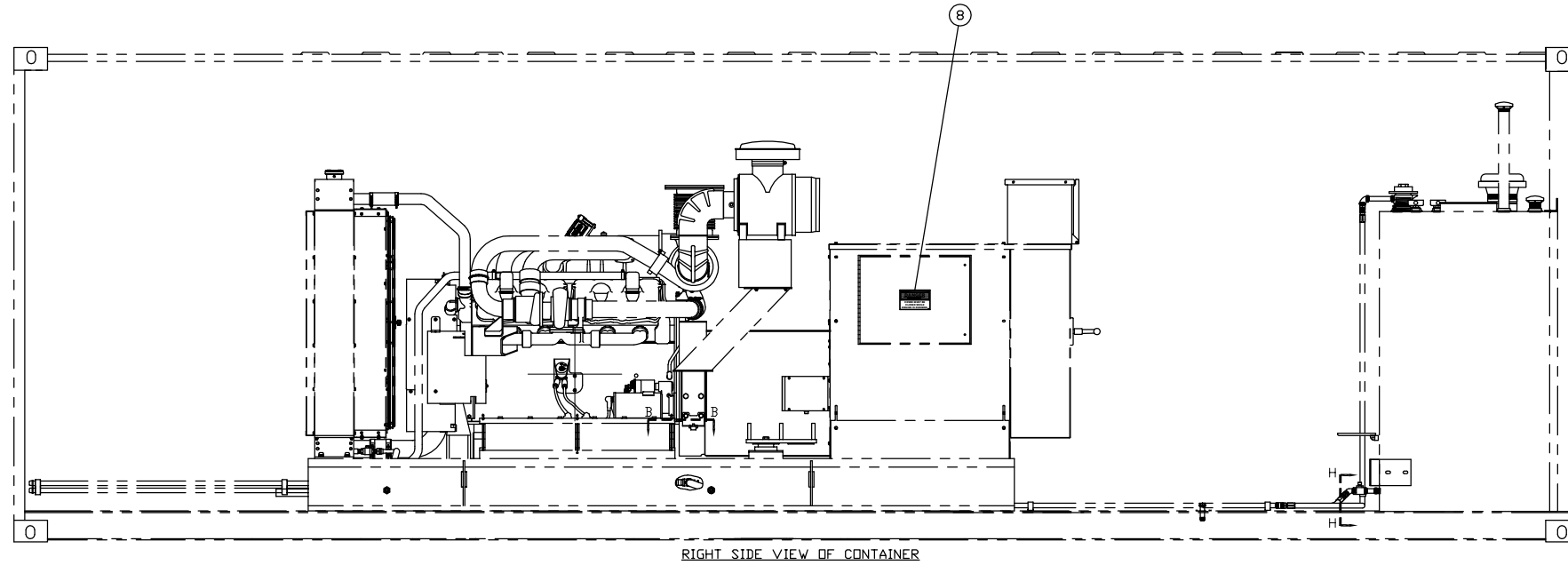

SECTION G-G
AT B-7
SCALE 2=1

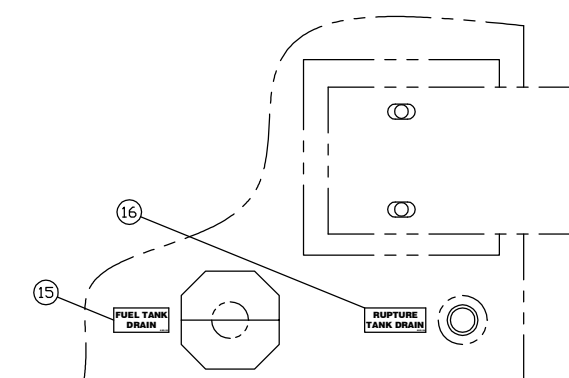

SECTION H-H
AT E-4
SCALE 5=1

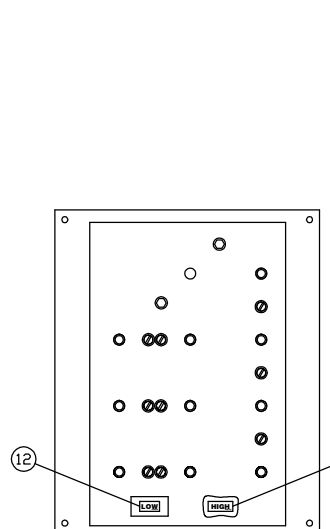

SECTION C-C
AT D-6
SCALE 4=1

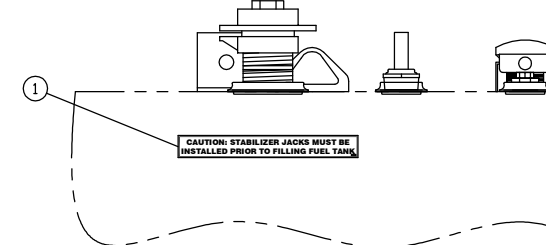

SECTION A-A
AT B-7
SCALE 3=1

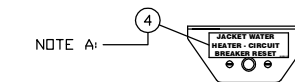

SECTION B-B
AT E-6
SCALE 5=1

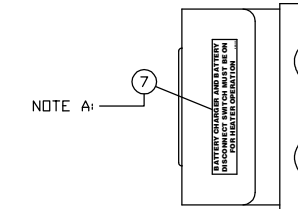

SECTION D-D
AT A-5
SCALE 5=1

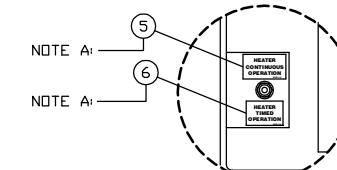

VIEW E
AT A-5
SCALE 5=1

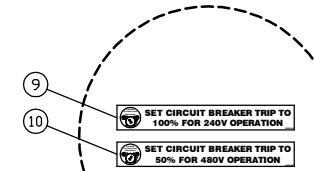

VIEW J
AT E-3
SCALE 5=1

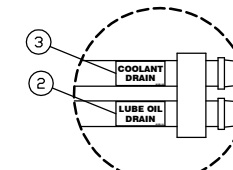

VIEW F
AT A-4
SCALE 5=1

NOTE A: INSTALL WHEN DIESEL FIRED JACKET WATER HEATER IS SUPPLIED

7/15/05 DATE BY		ALTORFER		ALTORFER POWER SYSTEMS	
		6315 W. FAUBER RD.		PHONE (309) 697-1234	
		BARTONVILLE, IL 61607		FAX (309) 282-7546	
THIS DOCUMENT CONTAINS PROPRIETARY INFORMATION OF ALTORFER, INC. WITHOUT THE WRITTEN PERMISSION OF ALTORFER, INC., ANY COPYING OR OTHER USE EXCEPT THAT FOR WHICH IT WAS INTENDED IS PROHIBITED.		FILE	PROJECT REFERENCE		
ADD COMP 17	DF/80G	SCALE/SHEET SIZE	DRAWN BY	QUOTE NUMBER	
CHANGE NOTICE	1=20/D	1=20/D	J. DLTMAN		
ALL DIMENSIONS IN INCHES UNLESS OTHERWISE SPECIFIED	SHEET	1 OF 1	DATE	WORK ORDER NUMBER	
TOLERANCES: XX ± 0.100 ANGLE XXX ± 0.060 PROJECTION XXX ± 0.005			1-21-05		
ANGULAR ± 1°					
TITLE	INTERIOR FILM GROUP			DRAWING NUMBER	
				80G101-01	

ITEM	QTY.	PART NO.	DESCRIPTION
1	1	80G109	INFORMATIONAL FILM
2	1	80G111	INFORMATIONAL FILM
3	1	80G112	INFORMATIONAL FILM
4	1	80G113	INFORMATIONAL FILM
5	1	80G114	INFORMATIONAL FILM
6	1	80G116	INFORMATIONAL FILM
7	1	80G117	INFORMATIONAL FILM
8	1	80G118	INFORMATIONAL FILM
9	1	80G119	INFORMATIONAL FILM
10	1	80G120	INFORMATIONAL FILM
11	1	80G123	INFORMATIONAL FILM
12	1	80G124	INFORMATIONAL FILM
13	1	198-1435	FILM-INSTRUCTION
14	1	144-0840	FILM-INFO
15	1	80G125	INFORMATIONAL FILM
16	1	80G126	INFORMATIONAL FILM
17	1	80G130	INFORMATIONAL FILM

INCH 80G102-01

ITEM	QTY.	PART NO.	DESCRIPTION
1	2	80G108	INFORMATIONAL FILM
2	1	80G122	INFORMATIONAL FILM
3	1	4W-5138	FILM-SYMBOL
4	1	9Y-4275	FILM
5	1	80G128	INFORMATIONAL FILM
6	1	80G129	INFORMATIONAL FILM

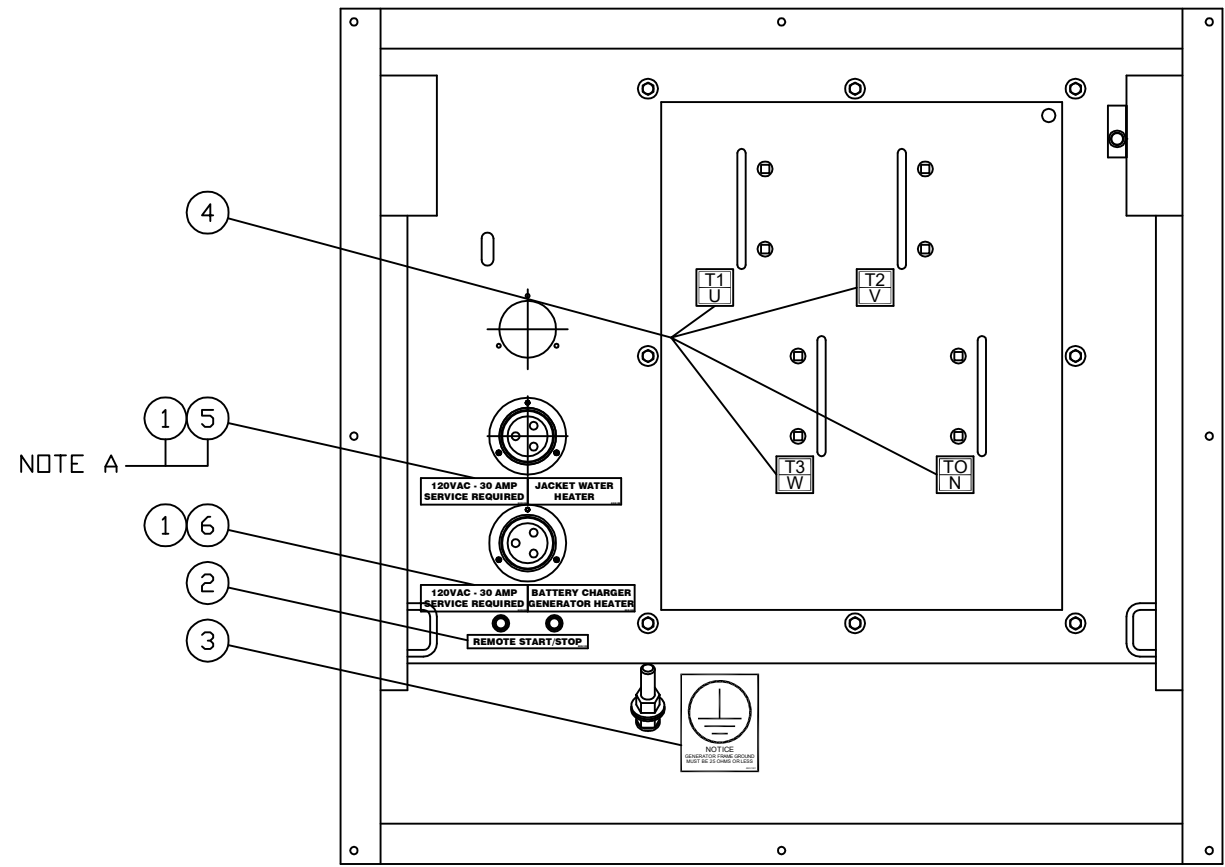

NOTE A

NOTE A: INSTALL WHEN OPTIONAL ELECTRIC JACKET WATER HEATER IS INSTALLED

7/18/05 DKR DATE	BY	ALTORFER			ALTORFER POWER SYSTEMS			
		6315 W. FAUBER RD. PHONE (309) 697-1234			BARTONVILLE, IL 61607 FAX (309) 282-7546			
THIS DOCUMENT CONTAINS PROPRIETARY INFORMATION OF ALTORFER, INC. WITHOUT THE WRITTEN PERMISSION OF ALTORFER, INC., ANY COPYING OR OTHER USE EXCEPT THAT FOR WHICH IT WAS INTENDED IS PROHIBITED								
UPDATE FOR ELECTRIC JWH	CHANGE NOTICE	ALL DIMENSIONS IN INCHES UNLESS OTHERWISE SPECIFIED		FILE	PROJECT REFERENCE			
				DF/80G	APS800			
		TOLERANCES: X.X ± 0.100 X.XX ± 0.060 X.XXX ± 0.005	THIRD ANGLE PROJECTION	SCALE/SHEET SIZE	DRAWN BY	QUOTE NUMBER		
				1=10/A	J. OLTMAN			
		ANGULAR ± 1°		SHEET	DATE	WORK ORDER NUMBER		
				1 OF 1	1-21-05			
		TITLE					DRAWING NUMBER	
		LOAD PAN FILM GROUP					80G102-01	
2	1	ND.						