



Alternators
LSA 46.2 - 4 Pole
Electrical and mechanical data

SPECIALY ADAPTED FOR APPLICATIONS

The LSA 46.2 alternator is designed to be suitable for typical generator applications, such as: backup, standard production, cogeneration, marine applications, rental, telecommunications, etc.

COMPLIANT WITH INTERNATIONAL STANDARDS

The LSA 46.2 alternator conforms to the main international standards and regulations:
IEC 60034, NEMA MG 1.22, ISO 8528/3, CSA, UL 1446, UL 1004B on request, marine regulations, etc.
It can be integrated into a CE marked generator.
The LSA 46.2 is designed, manufactured and marketed in an ISO 9001 environment.

TOP OF THE RANGE ELECTRICAL PERFORMANCE

- Class H insulation.
- Standard 12-wire re-connectable winding, 2/3 pitch, type no. 6 .
- Voltage range: 220 V - 240 V and 380 V - 415 V (440 V) - 50 Hz / 208 V - 240 V and 380 V - 480 V - 60 Hz.
- High efficiency and motor starting capacity.
- Other voltages are possible with optional adapted windings:
 - 50 Hz: 440 V (no. 7), 500 V (no. 9), 600 V (no. 22 or 23), 690 V (no. 10 or 52)
 - 60 Hz: 380 V and 416 V (no. 8), 600 V (no. 9).
- Total harmonic content < 2,5 %.
- R 791 interference suppression conforming to standard EN 55011 group 1 class B standard for European zone (CE marking).

EXCITATION AND REGULATION SYSTEM SUITED TO THE APPLICATION

Excitation system				Regulation options				
Voltage regulator	SHUNT	AREP	PMG	T.I. Current transformer for paralleling	R 726 Mains paralleling	R 731 3-phase sensing	R 734 3-phase sensing on mains paralleling unbalanced	P Remote voltage potentiometer
R 250	Std	-	-	-	-	-	-	√
R 448	optional	Std	Std	√	√	√	√	√
DECS 100	-	optional	optional	√	included	included	NA	√

Voltage regulator accuracy +/- 0.5% - √ : possible adaptation - NA : not possible.

PROTECTION SYSTEM SUITED TO THE ENVIRONMENT

- The LSA 46. 2 is IP 23.
- Standard winding protection for clean environments with relative humidity δ 95 %, including indoor marine environments.
- Options:
 - Filters on air inlet and air outlet (IP 44).
 - Winding protections for harsh environments and relative humidity greater than 95%.
 - Space heaters.
 - Thermal protection for windings and shields.

REINFORCED MECHANICAL STRUCTURE USING FINITE ELEMENT MODELLING

- Compact and rigid assembly to better withstand generator vibrations.
- Steel frame.
- Cast iron flanges and shields.
- Twin-bearing and single-bearing versions designed to be suitable for engines on the market.
- Half-key balancing.
- Greased for life bearings (regreasable bearings optional).

ACCESSIBLE TERMINAL BOX PROPORTIONED FOR OPTIONAL EQUIPMENT

- Easy access to the voltage regulator and to the connections.
- Possible clusion of accessories for paralleling, protection and measurement.
- 8 way terminal block for reconnecting voltage reconnection.
- DECS 100 digital AVR adapted to the machine exterior.

Common data

Insulation class	H	Excitation system	SHUNT	A R E P or PMG
Winding pitch	2/3 (N° 6)	A.V.R. model	R 250	R 448
Terminals	12	Voltage regulation (*)	± 0,5 %	± 0,5 %
Drip proof	IP 23	Sustained short-circuit current	-	300% (3 IN) : 10s
Altitude	≤ 1000 m	Total harmonic TGH / THC (**)	at no load < 2,5 % - on load < 2,5 %	
Overspeed	2250 min ⁻¹	Waveform : NEMA = TIF (**)	< 50	
Air flow	0,43 m ³ /s (50Hz)/0,51 (60Hz)	Wave form : I.E.C. = THF (**)	< 2 %	

(*) Steady state duty. (**) Total harmonic content line to line, at no load or full rated linear and balanced load.

Ratings 50 Hz - 1500 R.P.M.

kVA / kW - Power factor = 0,8																					
Duty T°C		Continuous duty 40°C					Continuous duty 40°C					Stand-by / 40 °C		Stand-by / 27 °C							
Class / T° K		H / 125° K					F / 105° K					H / 150° K		H / 163° K							
Phase		3 ph.			1 ph.	3 ph.			1 ph.	3 ph.		1 ph.	3 ph.			1 ph.					
Y		380V	400V	415V	440V	ΔΔ	380V	400V	415V	440V	ΔΔ	380V	400V	415V	440V	ΔΔ	380V	400V	415V	440V	ΔΔ
Δ		220V	230V	240V	230V		220V	230V	240V	230V		220V	230V	240V	230V		220V	230V	240V	230V	
YY					220V				220V					220V					220V		
46.2 M3	kVA	180	180	180	160	104	168	168	168	146	97	195	195	195	175	110	203	203	203	180	114
	kW	144	144	144	128	83	134	134	134	116	78	156	156	156	140	88	162	162	162	144	91
46.2 M5	kVA	200	200	200	175	116	184	184	184	160	108	214	214	214	190	123	223	223	223	200	127
	kW	160	160	160	140	93	147	147	147	128	86	171	171	171	152	98	178	178	178	160	102
46.2 L6	kVA	250	250	240	205	141	217	217	217	190	131	254	260	254	225	150	266	275	266	237	156
	kW	200	200	192	164	113	174	174	174	152	105	203	208	203	180	120	213	220	213	190	125
46.2 L9	kVA	280	280	280	215	154	250	250	250	195	142	290	290	290	240	165	300	300	300	250	170
	kW	224	224	224	172	123	200	200	200	156	114	232	232	232	192	132	240	240	240	200	136
46.2 VL12	kVA	315	315	300	260	187	276	276	260	230	170	327	327	310	285	200	341	341	325	300	208
	kW	252	252	240	208	150	221	221	208	184	136	262	262	248	228	160	273	273	260	240	166

Ratings 60 Hz - 1800 R.P.M.

kVA / kW - Power factor = 0,8																					
Duty T°C		Continuous duty 40°C					Continuous duty 40°C					Stand-by / 40 °C		Stand-by / 27 °C							
Class / T° K		H / 125° K					F / 105° K					H / 150° K		H / 163° K							
Phase		3 ph.			1 ph.	3 ph.			1 ph.	3 ph.		1 ph.	3 ph.			1 ph.					
Y		380V	416V	440V	480V	ΔΔ	380V	416V	440V	480V	ΔΔ	380V	416V	440V	480V	ΔΔ	380V	416V	440V	480V	ΔΔ
Δ		220V	240V		240V		220V	240V		240V		220V	240V		240V		220V	240V		240V	
YY			208V	220V	240V			208V	220V	240V			208V	220V	240V			208V	220V	240V	
46.2 M3	kVA	192	205	220	228	128	177	189	198	210	119	203	219	228	244	136	211	225	237	255	141
	kW	154	164	176	182	102	142	151	158	168	95	162	175	182	195	109	169	180	190	204	113
46.2 M5	kVA	205	219	230	250	136	190	203	211	225	126	219	235	245	262	145	227	242	252	273	151
	kW	164	175	184	200	109	152	162	169	180	101	175	188	196	210	116	182	194	202	218	121
46.2 L6	kVA	257	276	289	300	173	239	255	265	278	160	276	295	308	324	184	285	304	317	337	192
	kW	206	221	231	240	138	191	204	212	222	128	221	236	246	259	147	228	243	254	270	154
46.2 L9	kVA	296	316	328	343	197	273	291	302	302	182	313	338	351	357	209	326	348	366	375	220
	kW	237	253	262	274	158	218	233	242	242	146	250	270	281	286	167	261	278	293	300	176
46.2 VL12	kVA	333	357	372	381	220	309	329	341	347	200	359	383	397	412	235	370	399	415	429	243
	kW	266	286	298	305	176	247	263	273	278	160	287	306	318	330	188	296	319	332	343	194

Efficiencies 50 Hz - P.F. : 1 / P.F. : 0,8

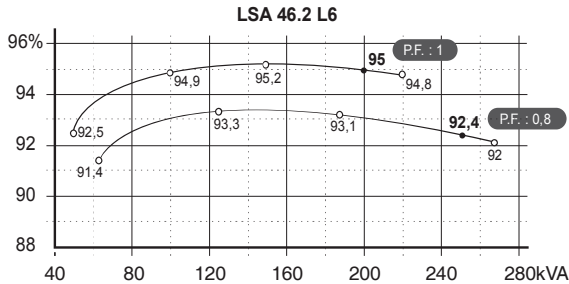
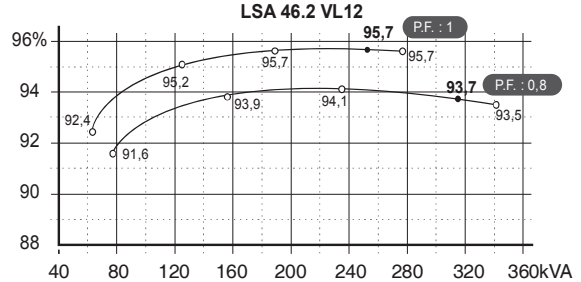
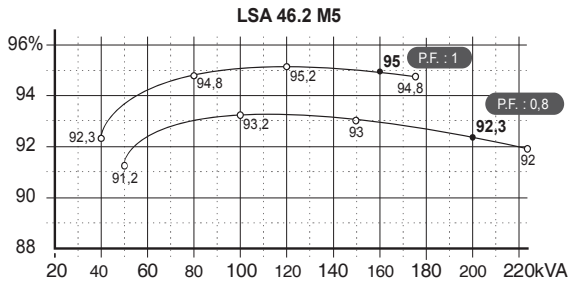
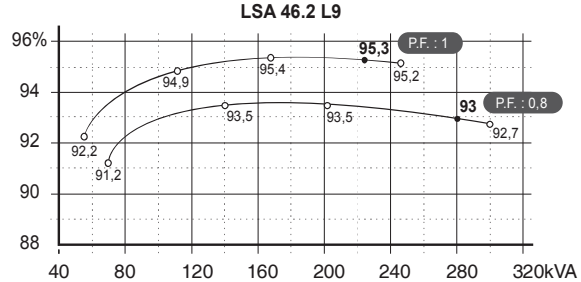
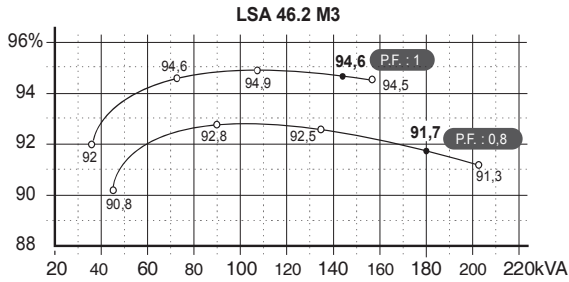

Reactances (%) . Time constants (ms) - Class H / 400 V

	M3	M5	L6	L9	VL12
Kcc Short-circuit ratio	0,44	0,45	0,41	0,48	0,5
Xd Direct axis synchro.reactance unsaturated	312	301	327	294	273
Xq Quadra. axis synch.reactance unsaturated	187	180	196	176	164
T'do Open circuit time constant	1971	2042	2105	2175	2253
X'd Direct axis transient reactance saturated	15,8	14,7	15,5	13,5	12,1
T'd Short-Circuit transient time constant	100	100	100	100	100
X''d Direct axis subtransient reactance saturated	9,5	8,8	9,3	8,1	7,2
T''d Subtransient time constant	10	10	10	10	10
X''q Quadra. axis subtransient reactance saturated	11,8	10,9	11,5	10	8,9
Xo Zero sequence reactance unsaturated	0,5	0,8	0,7	0,7	0,5
X2 Negative sequence reactance saturated	10,6	9,9	10,4	9,1	8,1
Ta Armature time constant	15	15	15	15	15

Other data - Class H / 400 V

	M3	M5	L6	L9	VL12
io (A) No load excitation current (SHUNT / AREP or PMG)	1	1	1	1,1	1
ic (A) Full load excitation current (SHUNT / AREP or PMG)	3,9	3,7	4	3,9	3,4
uc (V) Full load excitation voltage (SHUNT / AREP or PMG)	33	32	34	33	33
ms Recovery time ($\Delta U = 20\%$ trans.)	500	500	500	500	500
kVA Motor start. ($\Delta U = 20\%$ sust.) or ($\Delta U = 50\%$ trans.) SHUNT	340	397	462	538	694
kVA Motor start. ($\Delta U = 20\%$ sust.) or ($\Delta U = 50\%$ trans.) AREP	371	434	504	583	760
% Transient dip (rated step load) SHUNT / PF : 0,8 LAG	16,2	15,4	15,9	14,6	12,9
% Transient dip (rated step load) AREP / PF : 0,8 LAG	14,3	13,7	14,1	13	11,4
W No load losses	2810	3040	3690	4340	4800
W Heat rejection	12900	13180	16400	16810	16730

Transient voltage variation 400 V - 50 Hz

Load application (SHUNT excitation)

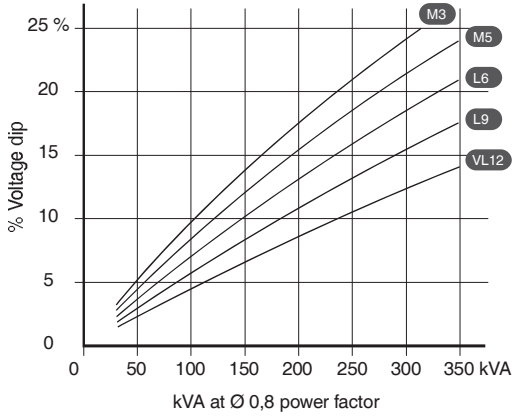

Load application (AREP or PMG excitation)

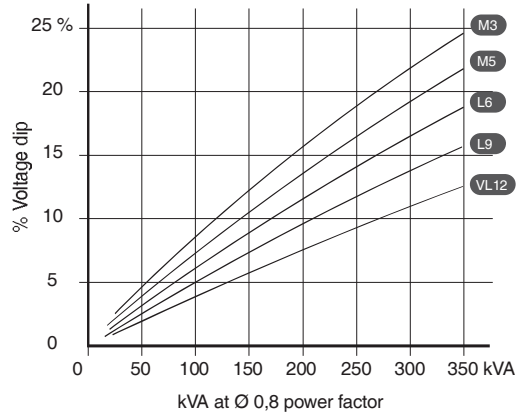

Load rejection (SHUNT excitation)

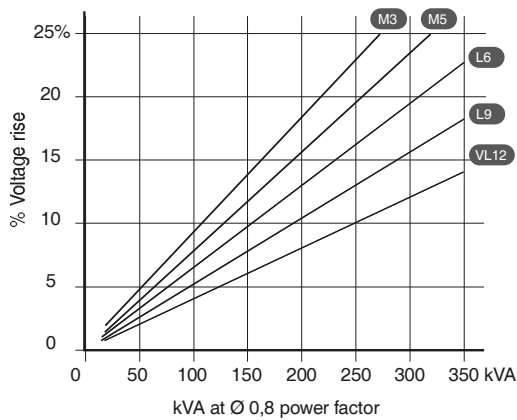

Load rejection (AREP or PMG excitation)

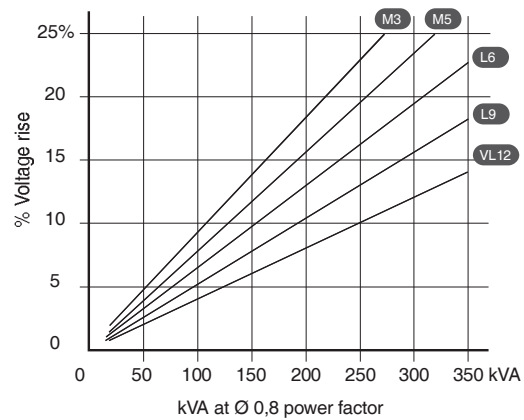

Motor starting (SHUNT excitation)

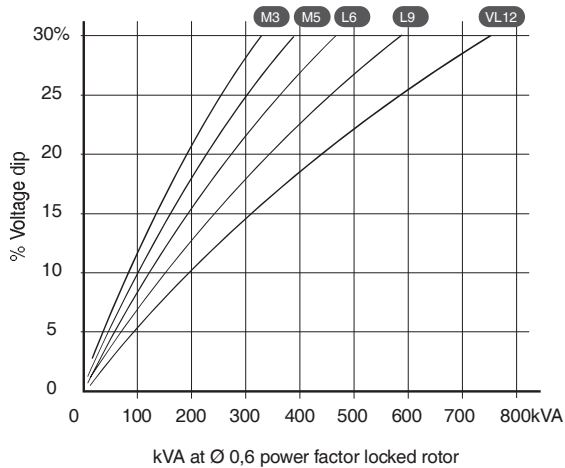

Motor starting (AREP or PMG excitation)

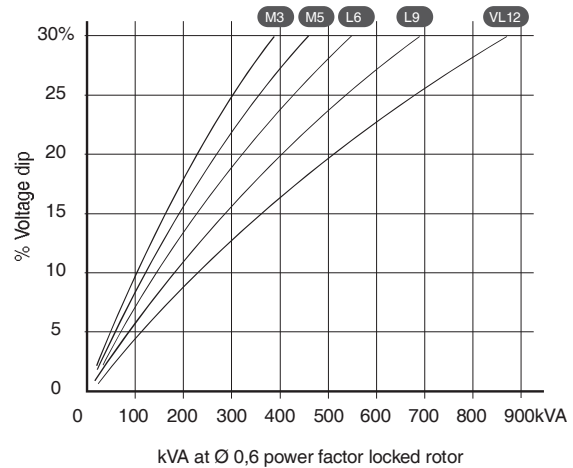

1) For a starting P.F. differing from 0,6 , the starting kVA must be multiplied by (Sine Ø /0,8)

2) For voltages other than 400V(Y) , 230V(Δ) at 50 Hz, then kVA must be multiplied by (400/U)² or (230/U)².

Efficiencies 60 Hz - P.F. :1 / P.F. : 0,8

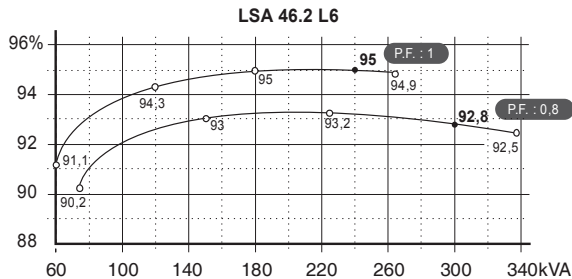
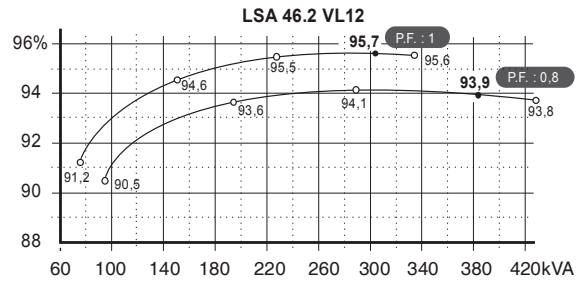
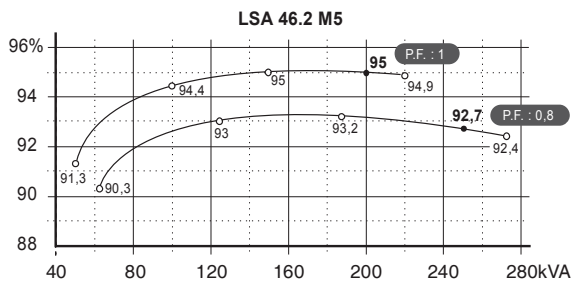
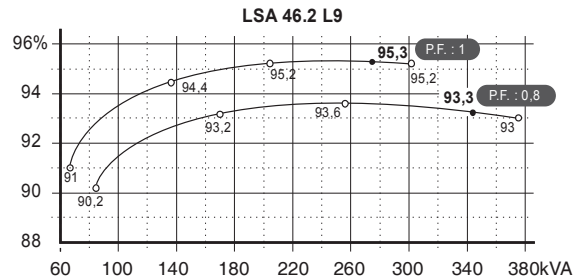
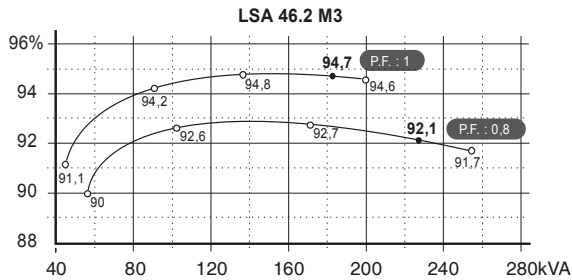

Reactances (%) . Time constants (ms) - Class H / 480 V

	M3	M5	L6	L9	VL12
Kcc Short-circuit ratio	0,41	0,43	0,41	0,47	0,5
Xd Direct axis synchro.reactance unsaturated	329	314	327	300	275
Xq Quadra. axis synchr.reactance unsaturated	197	188	196	180	165
T'do Open circuit time constant	1971	2042	2105	2175	2253
X'd Direct axis transient reactance saturated	16,7	15,3	15,5	13,8	12,2
T'd Short circuit transient time constant	100	100	100	100	100
X''d Direct axis subtransient reactance saturated	10	9,2	9,3	8,2	7,3
T''d Subtransient time constant	10	10	10	10	10
X''q Quadra. axis subtransient reactance saturated	12,4	11,4	11,5	10,2	9
Xo Zero sequence reactance unsaturated	0,5	0,5	0,6	0,4	0,4
X2 Negative sequence reactance saturated	11,2	10,3	10,4	9,3	8,2
Ta Armature time constant	15	15	15	15	15

Other data - Class H / 480 V

io (A) No load excitation current (SHUNT / AREP or PMG)	1	1	1	1,1	1
ic (A) Full load excitation current (SHUNT / AREP or PMG)	4	3,8	3,9	3,8	3,4
uc (V) Full load excitation voltage (SHUNT / AREP or PMG)	34	32	33	33	33
ms Recovery time ($\Delta U = 20\%$ trans.)	500	500	500	500	500
kVA Motor start. ($\Delta U = 20\%$ sust.) or ($\Delta U = 50\%$ trans.) SHUNT	420	496	575	673	867
kVA Motor start. ($\Delta U = 20\%$ sust.) or ($\Delta U = 50\%$ trans.) AREP	461	540	629	732	953
% Transient dip (rated step load) SHUNT / PF : 0,8 LAG	16,7	15,8	15,9	14,8	13
% Transient dip (rated step load) AREP / PF : 0,8 LAG	14,8	14,1	14,1	13,1	11,5
W No load losses	4180	4500	5530	6430	7090
W Heat rejection	15570	15680	18500	19690	19510

Transient voltage variation - 480 V - 60 Hz

Load application (SHUNT excitation)

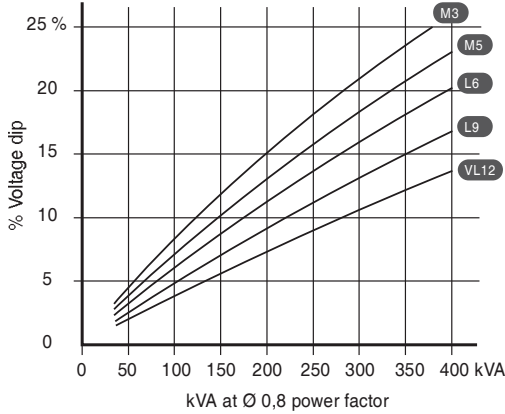

Load application (AREP or PMG excitation)

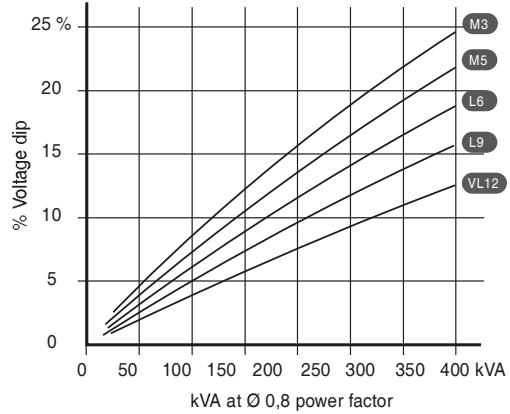

Load rejection (SHUNT excitation)

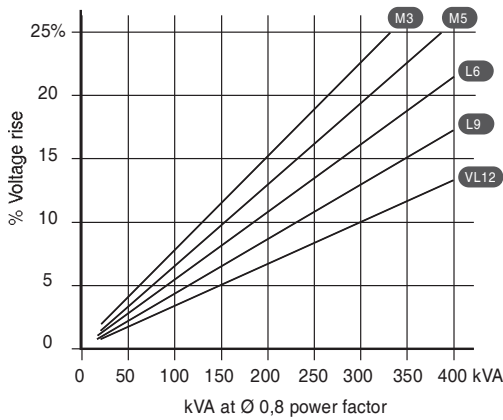

Load rejection (AREP or PMG excitation)

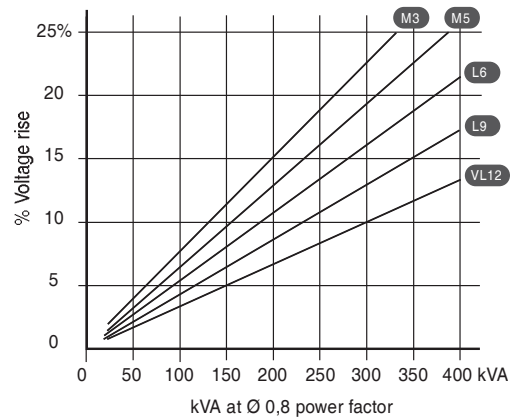

Motor starting (SHUNT excitation)

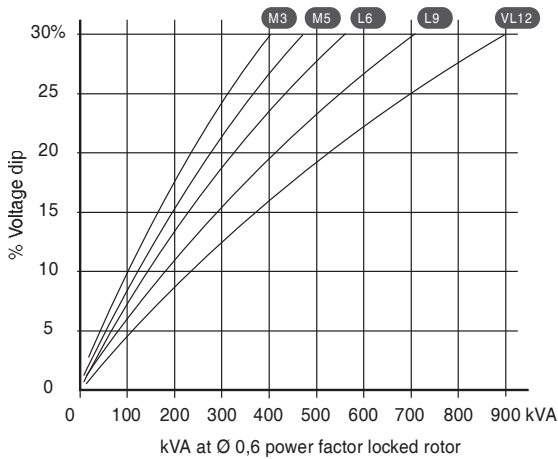

Motor starting (AREP or PMG excitation)

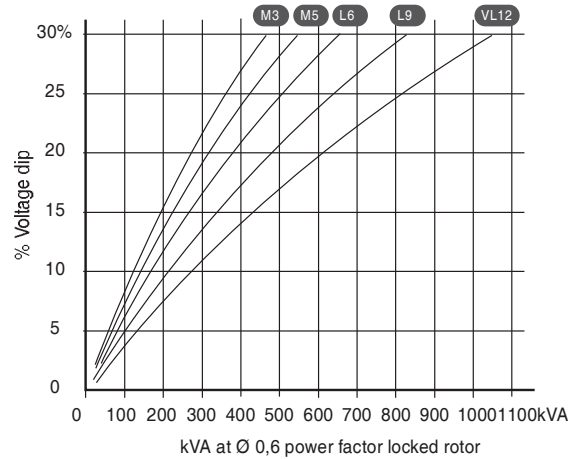

- 1) For a starting P.F. differing from 0,6 , the starting kVA must be multiplied by (Sine Ø /0,8)
- 2) For voltages other than 480V(Y), 277V(Δ), 240V(YY) at 60 Hz, then kVA must be multiplied by $(480/U)^2$ or $(277/U)^2$ or $(240/U)^2$

3 phase short-circuit curves at no load and rated speed (star connection Y)

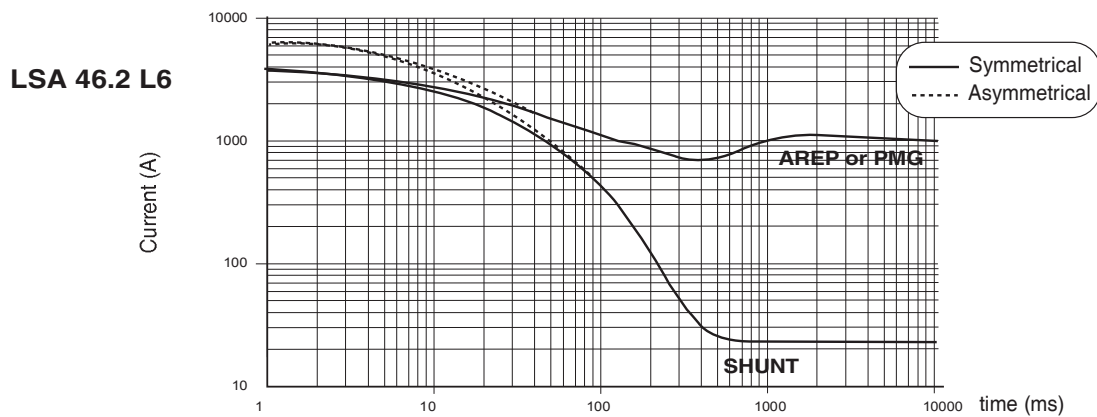
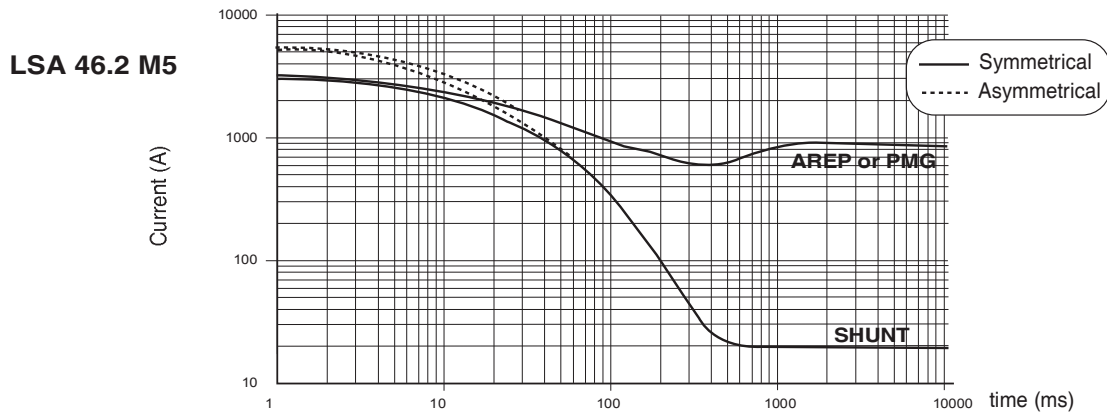
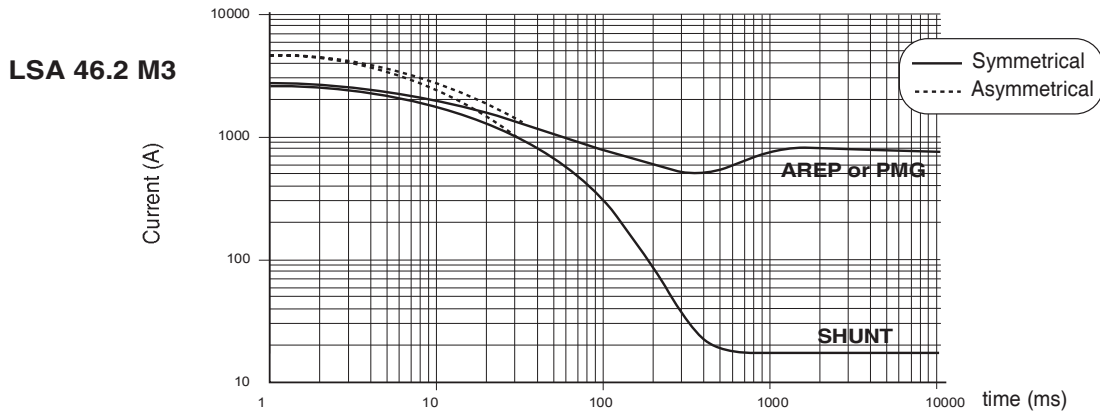

Influence due to connexion.

Curves shown are for star connection (Y).

For other connections, use the following multiplication factors :

- Series delta : Current value x 1,732
- Parallel star : Current value x 2

3 phase short-circuit curves at no load and rated speed (star connection Y)

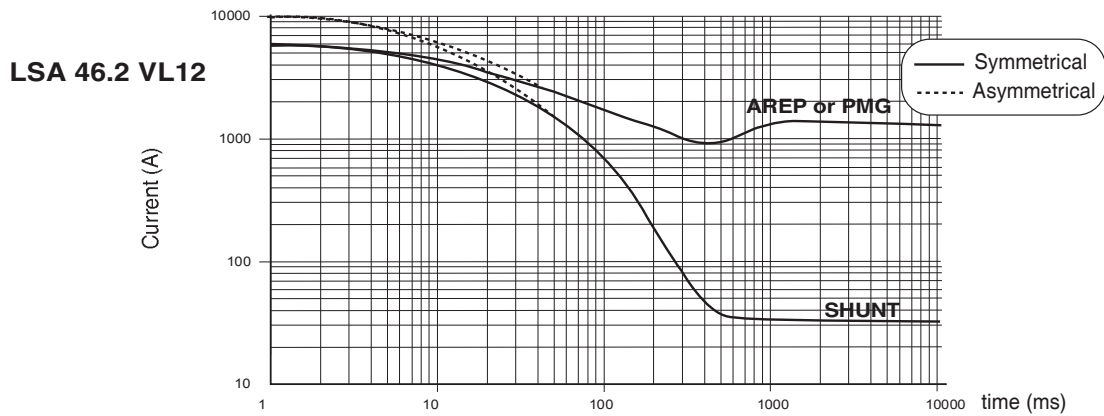
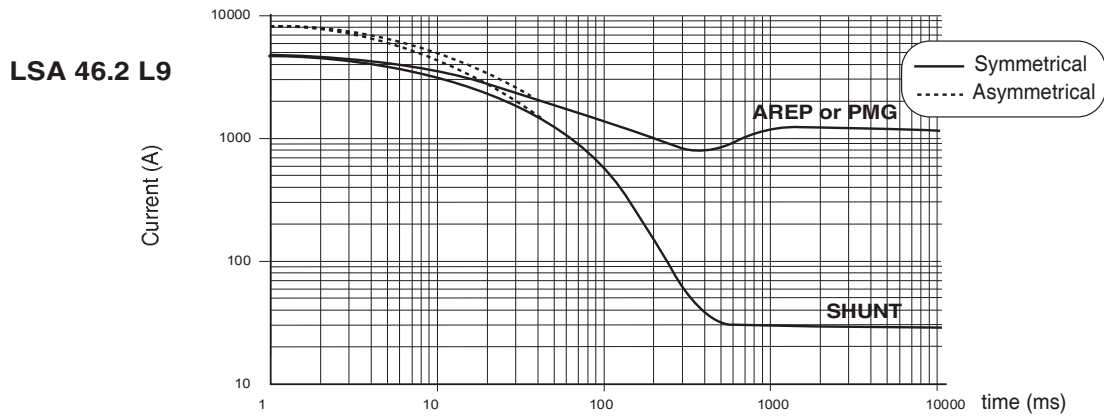

Influence due to short-circuit.

Curves are based on a three-phase short-circuit.

For other types of short-circuit, use the following multiplication factors:

	3 phase	2 phase L - L.	1 phase L - N.
Instantaneous (Max)	1	0,87	1,3
Sustained	1	1,5	2,2
Max sustained duration (AREP/ PMG)	10 sec.	5 sec.	2 sec.

Single bearing dimensions

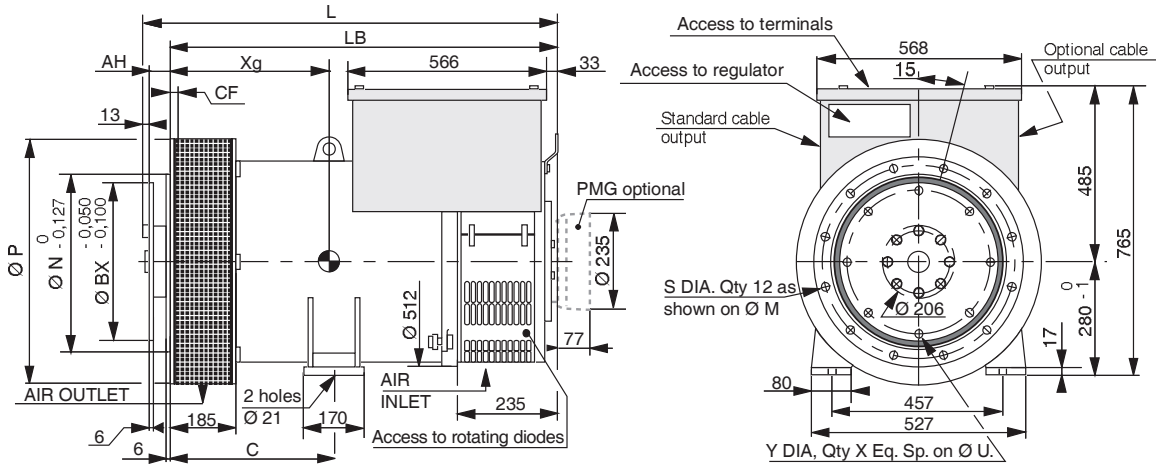

Frame dimensions					
TYPE	L max without PMG	LB	Xg	C	Weight (kg)
LSA 46.2 M3	973	920	460	429	585
LSA 46.2 M5	973	920	470	429	625
LSA 46.2 L6	1083	1030	460	429	710
LSA 46.2 L9	1083	1030	485	429	775
LSA 46.2 VL12	1175	1130	530	525	895

Coupling		
Flex plate	11 1/2	14
Flange S.A.E 3	X	
Flange S.A.E. 2	X	
Flange S.A.E 1	X	X
Flange S.A.E. 1/2		X

Flange (mm)						
S.A.E.	P	N	M	S	R	CF
3	575*/623	409,575	428,625	11	345*/368	24*/17
2	575*/623	447,675	466,725	11	345*/368	24*/17
1	575*/623	511,175	530,225	12	345*/368	24*/17
1/2	651	584,2	619,125	14,5	382	17

Flex plate (mm)					
S.A.E.	BX	U	X	Y	AH
11 1/2	352,42	333,38	8	11	39,6
14	466,72	438,15	8	14	25,4

* : dimensions LSA 46,2 M

Torsional analysis data

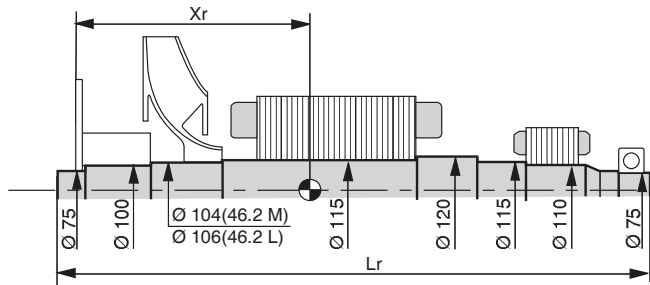

Gravity center : Xr (mm), Rotor length Lr (mm), Weight : M (kg), Moment of inertia : J (kgm ²) : (4J = MD ²)								
TYPE	Flex plate S.A.E. 11 1/2				Flex plate S.A.E. 14			
	Xr	Lr	M	J	Xr	Lr	M	J
LSA 46.2 M3	422	935	229	1,78	407	935	229,4	1,909
LSA 46.2 M5	434	935	245	1,948	419	935	245,3	2,077
LSA 46.2 L6	466	1045	278	2,329	451	1045	278,8	2,458
LSA 46.2 L9	485	1045	304,3	2,605	474	1045	304,9	2,724
LSA 46.2 VL12	540	1145	357	3,1	529	1145	357,6	3,216

Two bearing dimensions

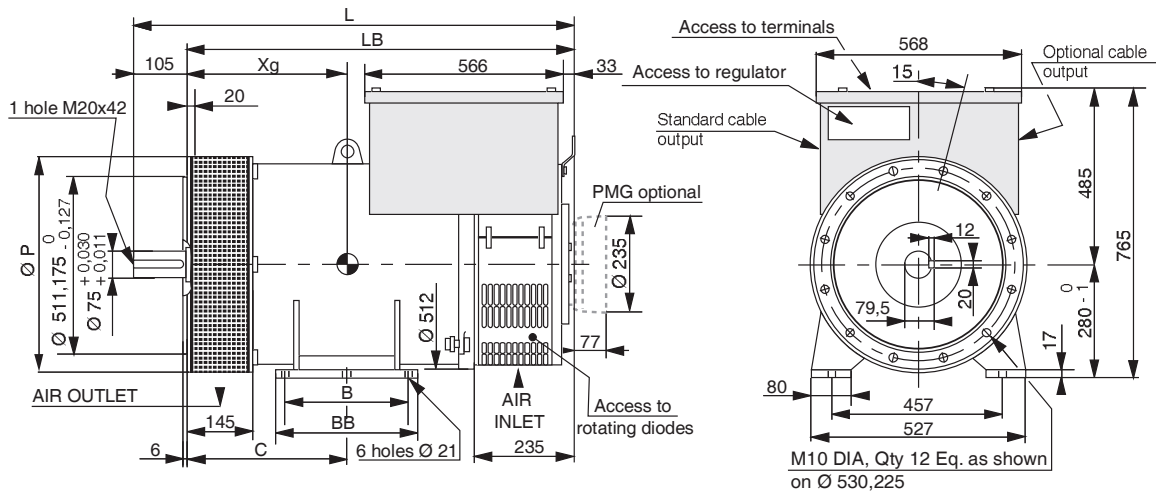

Frame dimensions

TYPE	L max without PMG	LB	P	C	BB	B	R	Xg	Weight (kg)
LSA 46.2 M3	985	880	575	389	418	368	345	400	570
LSA 46.2 M5	985	880	575	389	418	368	345	410	615
LSA 46.2 L6	1095	990	623	389	418	368	368	430	705
LSA 46.2 L9	1095	990	623	389	418	368	368	455	770
LSA 46.2 VL12	1195	1090	623	485	610	560	368	500	885

Torsional analysis data

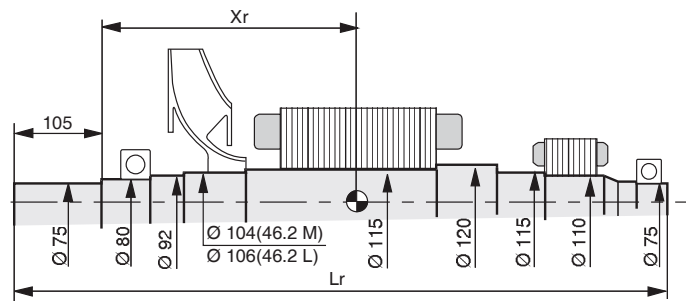

Gravity center : Xr (mm), Rotor length Lr (mm), Weight : M (kg), Moment of inertia : J (kgm²) : (4J = MD²)

TYPE	Xr	Lr	M	J
LSA 46.2 M3	395	955	199,9	1,57
LSA 46.2 M5	404	955	215,8	1,738
LSA 46.2 L6	436	1065	247,6	2,109
LSA 46.2 L9	453	1065	273,7	2,385
LSA 46.2 VL12	502	1165	323,8	2,845

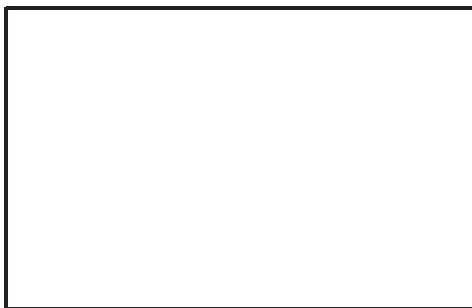

MOTEURS LEROY-SOMER 16015 ANGOULÊME CEDEX - FRANCE

338 567 258 RCS ANGOULÊME
S.A. au capital de 62 779 000 €

www.leroy-somer.com