

TO CUSTOMER
3 PH. LOAD

2500 A.F.
2500 A.T. ADJUSTABLE
3 POLE
CIRCUIT
BREAKER

DUAL VOLTAGE
CHANGE-OVER
BOARD

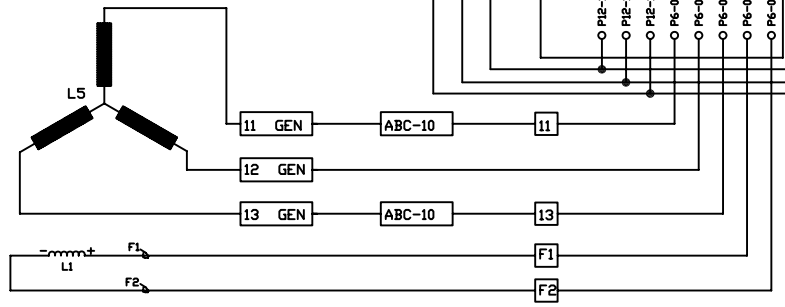
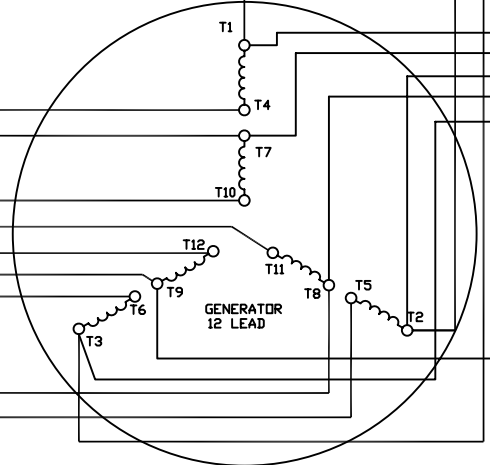
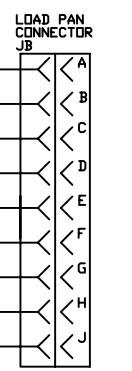
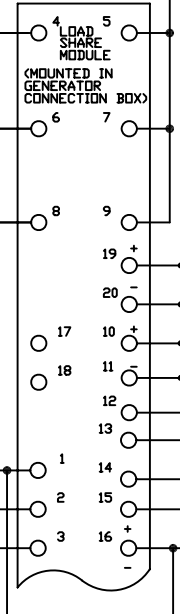
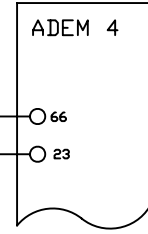
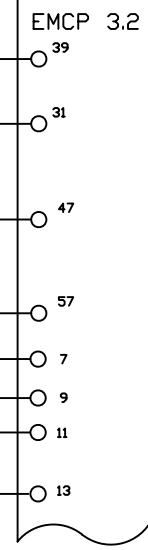
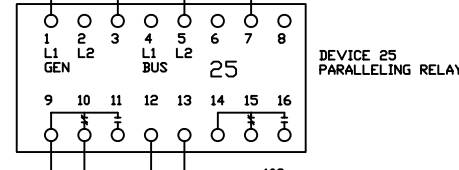
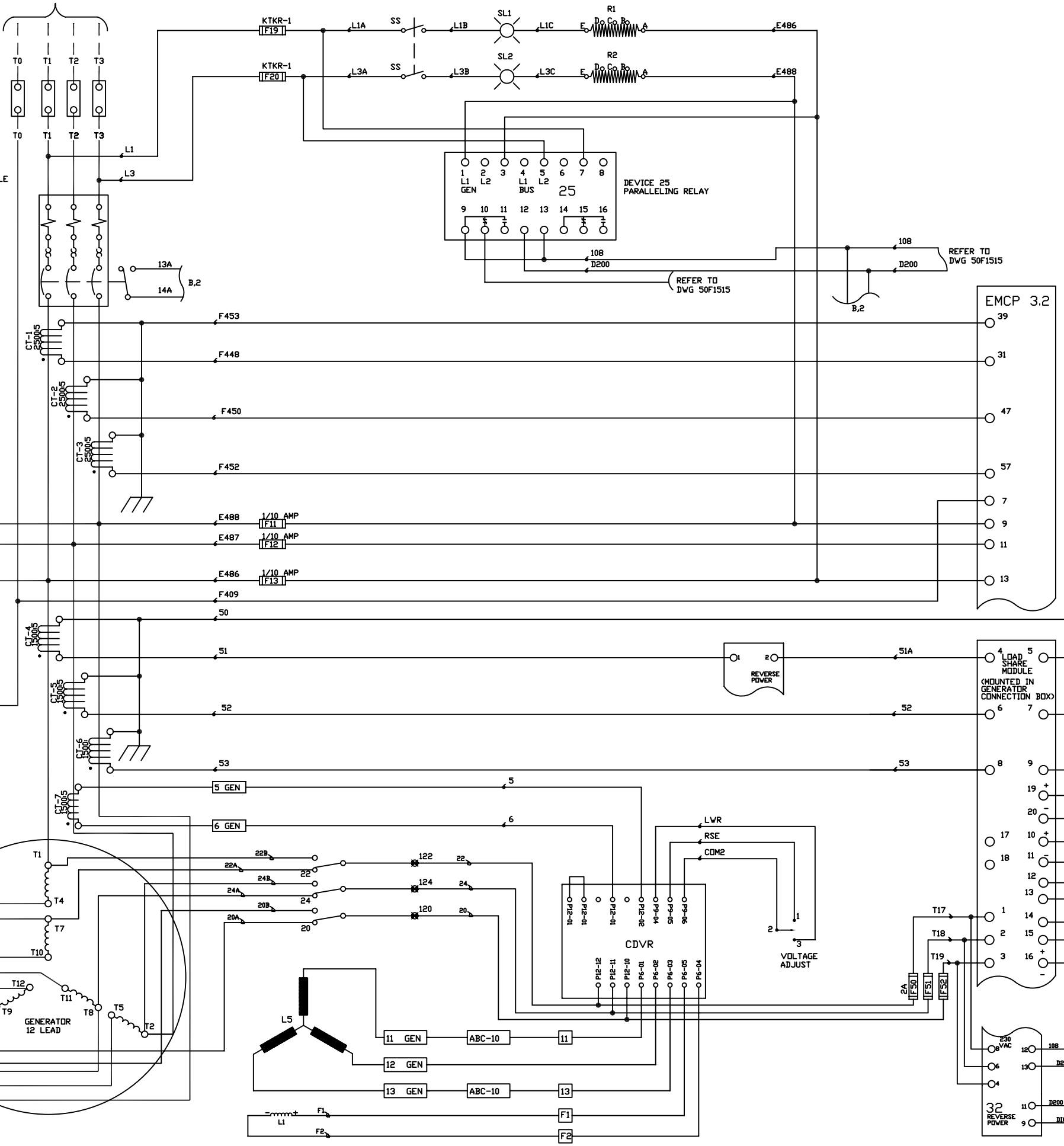

| | | | |
|--|---|---|---|
| | | ALTORFER POWER SYSTEMS 6315 W. FAUBER ROAD BARTONVILLE, IL 61807 PHONE (309) 897-1234 FAX (309) 282-7546 | |
| <small>THIS DOCUMENT CONTAINS PROPRIETARY INFORMATION OF ALTORFER, INC. WITHOUT THE WRITTEN PERMISSION OF ALTORFER, INC. ANY COPYING OR OTHER USE EXCEPT THAT FOR WHICH IT WAS INTENDED IS PROHIBITED.</small> | | | |
| <small>ALL DIMENSIONS IN INCHES UNLESS OTHERWISE SPECIFIED</small> | <small>FILE</small> DF\50F | <small>PROJECT REFERENCE</small> APSS50 POWER MODULE | |
| <small>TOLERANCES: XX ± 0.100 ANGLE PROJECTION</small> | <small>SCALE/SHEET SIZE</small> 1=L/D | <small>DRAWN BY</small> D. ROLING | <small>QUOTE NUMBER</small> |
| <small>XXX ± 0.065 XXXX ± 0.005</small> | <small>SHEET</small> 1 OF 1 | <small>DATE</small> 02/28/2010 | <small>WORK ORDER NUMBER</small> 468811 |
| <small>ANGULAR ± 1'</small> | <small>TITLE</small> CHANGE OVER BOARD GROUP GENERATOR AC SCHEMATIC | <small>DRAWING NUMBER</small> 50F1514 | |